

K22N

BAULETTO LATERALE MONOKEY - MONOKEY SIDE CASE - VALISES LATÉRALES MONOKEY
MONOKEY SEITENKOFFER - MALETA TRASERA MONOLOCK - MALA TRASEIRA MONOLOCK

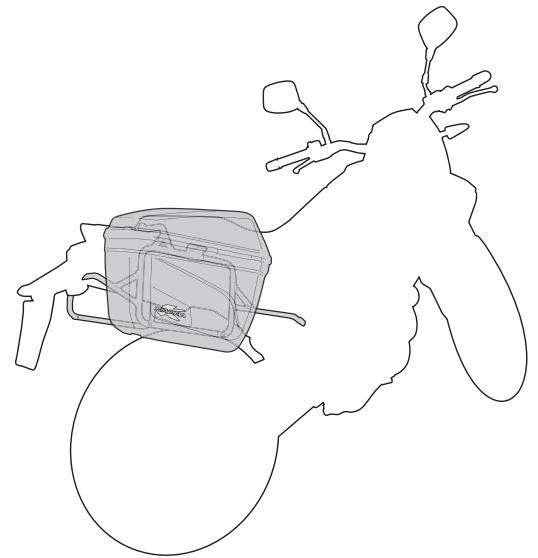

CLOSED

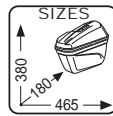
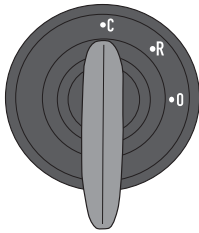

RELEASE

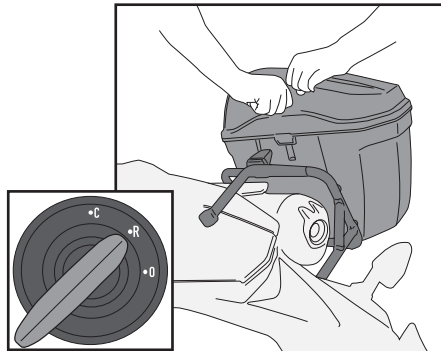

OPEN

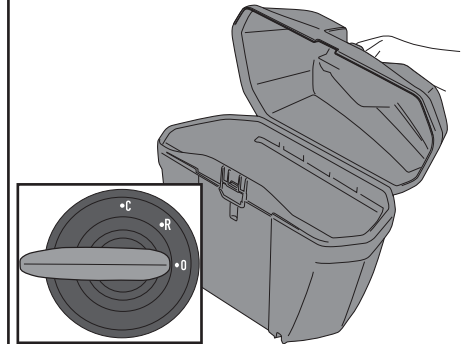

PER APRIRE IL BAULETTO - TO OPEN THE CASE - POUR OUVRIR LE TOP CASE - UN DEN KOFFER ZU ÖFFNEN - PARA ABRIR EL BAÚL - A ABRIR A MALA

INSERIRE LA CHIAVE NELLA SERRATURA;
RUOTARLA DI 90°, SULLA POSIZIONE "O";
APRIRE IL COPERCHIO DEL BAULETTO;

INSERT THE KEY IN THE LOCK;
TURN IT 90° IN "O" POSITION;
OPEN THE CASE;

INSÉREZ LA CLÉ DANS LA SERRURE
LA TOURNER DE 90° EN POSITION "O";
OUVRIR LE COUVERCLE DU COFFRE

STECKEN SIE DEN SCHLÜSSEL IN DAS SCHLOSS;
DREHEN SIE IHN UM 90°, BIS ZUR POSITION "O";
ÖFFNEN SIE DEN KOFFERDECKEL;

INTRODUCIR LA LLAVE EN LA CERRADURA;
GIRE 90° EN LA POSICIÓN "O";
ABRA LA CAJA;

INSIRA A CHAVE NA FECHADURA;
VIRE 90° PARA A POSIÇÃO "O";
ABRA A CAIXA;

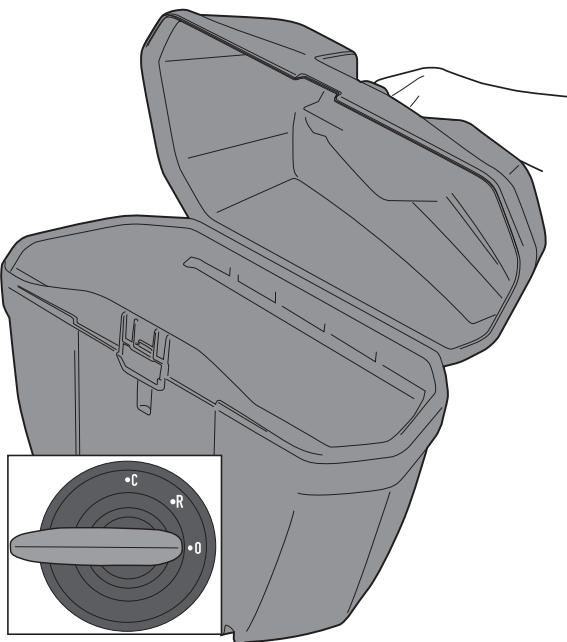

K22N

BAULETTO LATERALE MONOKEY - MONOKEY SIDE CASE - VALISES LATÉRALES MONOKEY MONOKEY SEITENKOFFER - MALETA TRASERA MONOLOCK - MALA TRASEIRA MONOLOCK

SGANCIO VALIGIA - RELEASE OF THE PANNIER - ABNEHMEN DES KOFFERS - RETRAIT DE LA VALISE
EXTRACCIÓN DE LA ALFORJA - LIBERAÇÃO DO BAÚ LATERAL

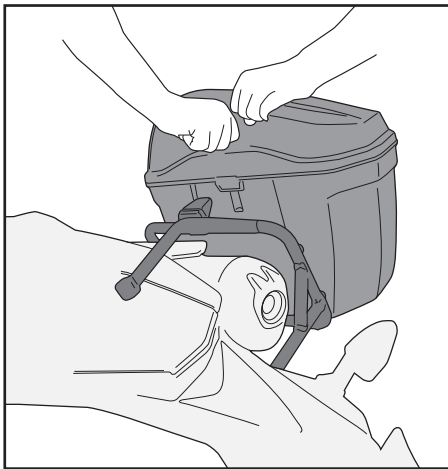
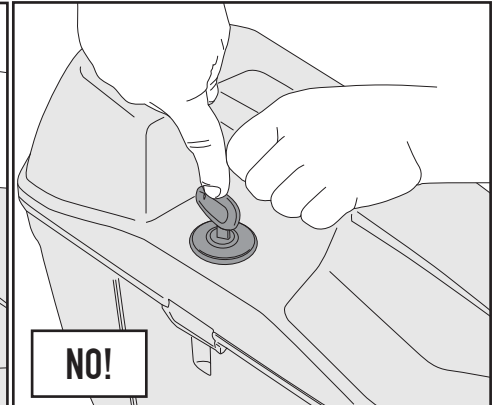
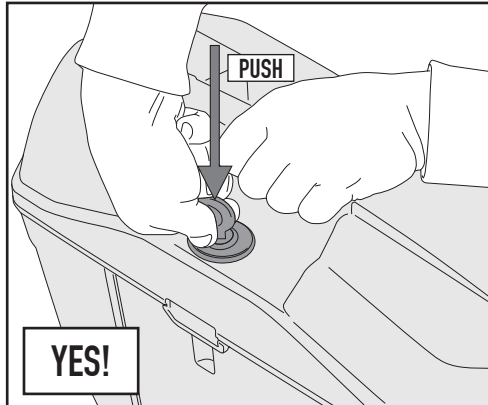
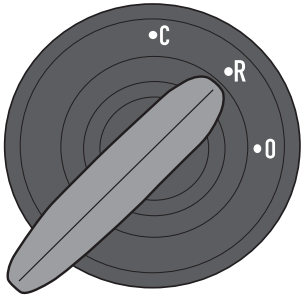

INSERIRE LA CHIAVE NELLA SERRATURA;
RUOTARLA DI 45°, SULLA POSIZIONE "R";
PREMERE LA CHIAVE STESSA;
SGANCIARE IL BAULETTO;

INSERT THE KEY IN THE LOCK;
TURN IT 45° IN "R" POSITION;
PUSH THE KEY;
DETACH THE CASE;

INSÉREZ LA CLÉ DANS LA SERRURE;
LA TOURNER DE 45°, EN POSITION "R";
APPUYER SUR LA CLÉ PUIS;
OUVRIR LE TOP CASE;

STECKEN SIE DEN SCHLÜSSEL IN DAS SCHLOSS;
DREHEN SIE IHN UM 45°, BIS ZUR POSITION "R";
DRÜCKEN SIE DEN DRUCKKNOPF;
NEHMEN SIE DEN KOFFER AB;

INSERTE LA LLAVE EN LA CERRADURA;
GIRE LA LLAVE DE 45°, EN LA POSICIÓN "R";
EMPUJE LA LLAVE;
LIBERAR LA MALETA;

INSIRA A CHAVE NA FECHADURA;
GIRE A CHAVE DE 45°, NA POSIÇÃO "R";
PRESSIONE A TECLA;
LIBERAR A MALA;

AGGANCIO VALIGIA - ATTACHMENT OF THE BAG - ACCROCHAGE DE LA VALISE - BEFESTIGUNG DES KOFFERS
COLGAR LA MALETA - PENDURAR A MALA

