







GILERA FUOCO 500cc '07

PIASTRA SPECIFICA - SPECIFIC PLATE
 PLATINE SPECIFIQUE - SPECIFISCHE PLATE - PARRILLA ESPECIFICA
 INSTRUZIONI DI MONTAGGIO - MOUNTING INSTRUCTIONS
 INSTRUCTIONS DE MONTAGE - BAUANLEITUNG - INSTRUCCIONES DE MONTAJE

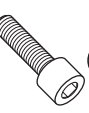
- 1**

SUPPORTO
 SUPPORT
 SUPPORT
 SUPPORT
 Q.TY n.2(Dx-Sx)
- 2**

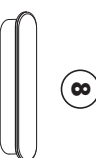
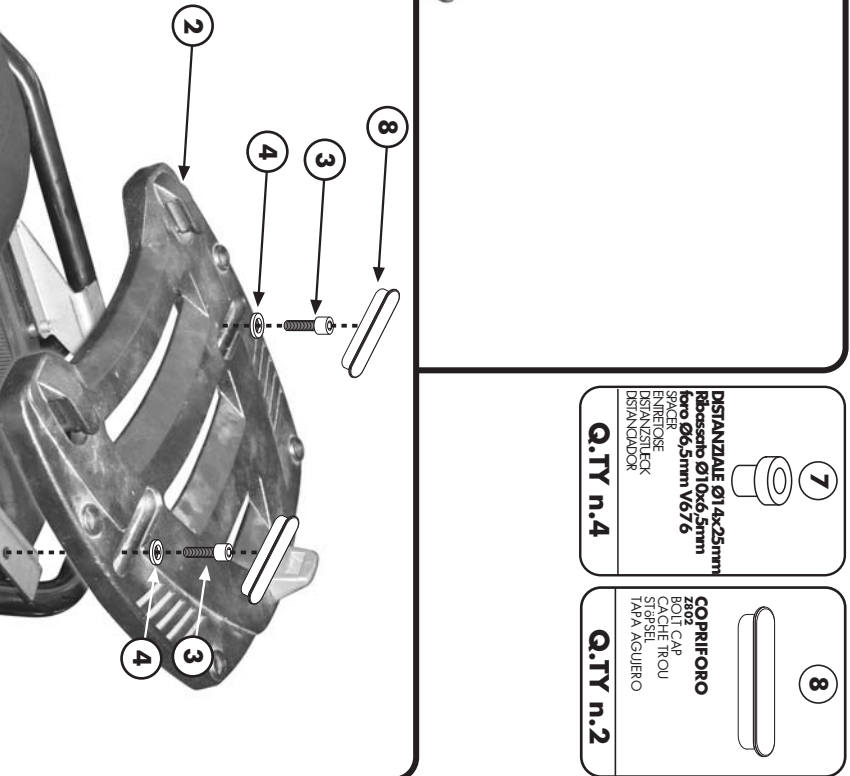
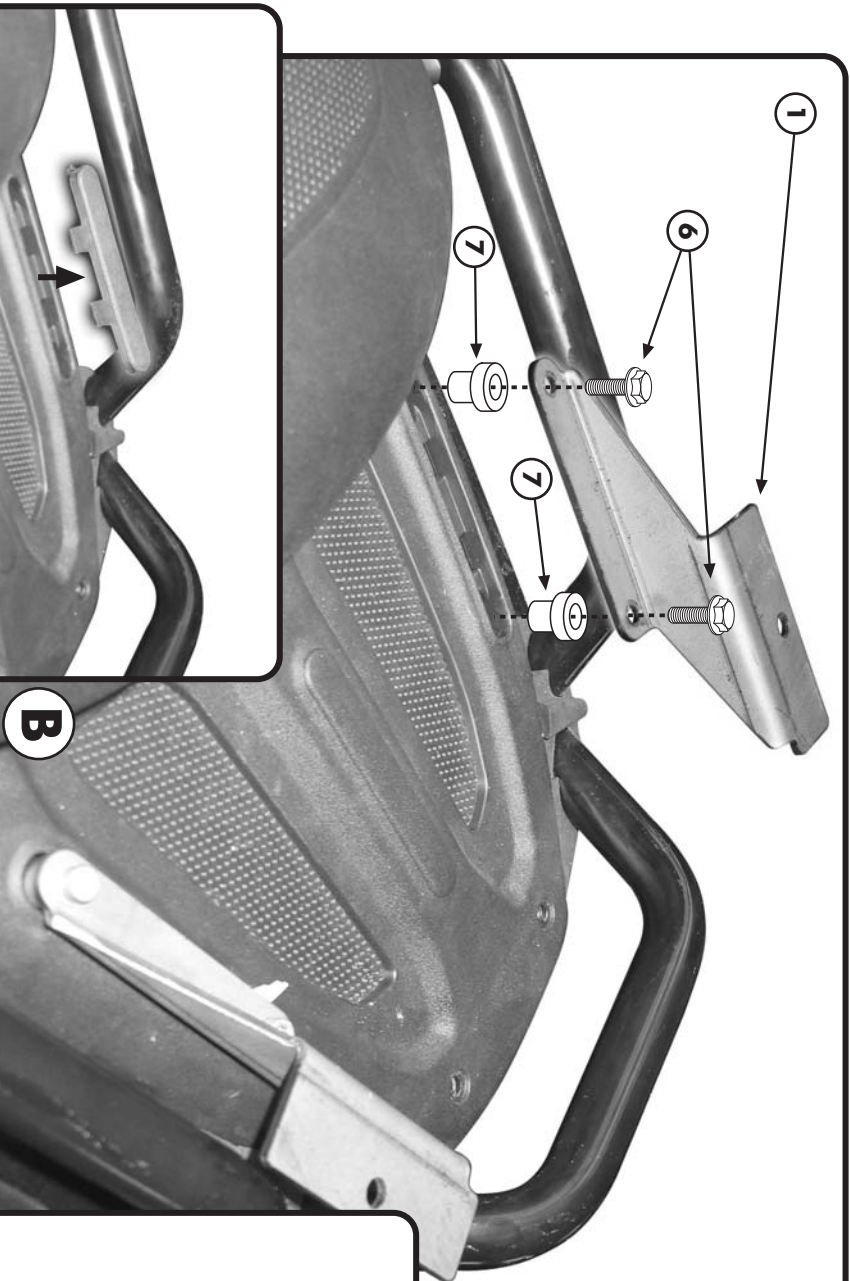
PIASTRA MONOCYTE
 PLATE
 PLATINE
 PARRILLA
 Q.TY n.1
- 3**

VITE TCEI M8x30mm
 SCREW M8x30mm
 VIS M8x30mm
 SCHRAUBE M8x30mm
 TORNILLO M8x30mm
 Q.TY n.2
- 4**

RONDELLA Ø8x14mm
 WASHER Ø8x14mm
 RONDELE Ø8x14mm
 SCHEIBE Ø8x14mm
 ARANDELA Ø8x14mm
 Q.TY n.2
- 5**

DADO A.B. M8
 BOLT M8
 ECHOU M8
 MÜLLER M8
 TUERCA M8
 Q.TY n.2
- 6**

VITE TEF M6x40mm
 SCREW M6x40mm
 VIS M6x40mm
 SCHRAUBE M6x40mm
 TORNILLO M6x40mm
 Q.TY n.4

- 7**

DISTANZIALE Ø1,4x25mm
 Spacer Ø1,4x25mm
 feno Ø6,5mm V6/76
 SPACER
 EINRETOE
 DISTANZSTUECK
 Q.TY n.4
- 8**

COPRIFORO
 BOLT CAP
 CÄCHE TROU
 STÄPSSEL
 TAPA AGUJERO
 Q.TY n.2



A

ATTENZIONE: PESO MASSIMO SOPPORTABILE 10Kg.
WARNING: MAX. LOADING OF THE CARRIER 10Kg. (21lbs)
ATTENTION: CHARGE MAXIMALE 10Kg.
ACHTUNG: MAXIMALE BELASTUNG 10Kg.
¡ATENCIÓN! CARGA MÁXIMA AUTORIZADA 10Kg.

B

C

E710 - K710

PIASTRA SPECIFICA - SPECIFIC PLATE
PLATINE SPECIFIQUE - SPEZIFISCHE PLATTE - PARRILLA ESPECIFICA

GILERA FUOCO 500cc '07

ISTRUZIONI DI MONTAGGIO - MOUNTING INSTRUCTIONS
INSTRUCTIONS DE MONTAGE - BAUANLEITUNG - INSTRUCCIONES DE MONTAJE

I ISTRUZIONI DI MONTAGGIO

1. TOGLIERE I GOMMINI ORIGINALI INDICATI IN FOTOGRAFIA A;
2. EFFETTUARE IL MONTAGGIO COME INDICATO IN FOTOGRAFIA B;
3. MONTARE LA PIASTRA PORTAVVALIGIA COME INDICATO IN FOTOGRAFIA C;
4. ULTIMARE IL MONTAGGIO VERIFICANDO CHE TUTTE LE VITI SIANO SERATE BENE (VITI M6=9,6Nm - VITI M8=23Nm) E I GOMMINI SIANO MONTATI CORRETTAMENTE SULLA PIASTRA.

GB MOUNTING INSTRUCTIONS

1. REMOVE THE ORIGINAL RUBBERS SHOWN IN PICTURE A;
2. CARRY OUT THE MOUNTING AS YOU CAN SEE IN PICTURE B;
3. SET THE LUGGAGE CARRIER AS YOU CAN SEE IN PICTURE C;
4. CHECK THAT ALL THE SCREWS ARE WELL TIGHTENED (SCREWS M6=9,6Nm - SCREWS M8=23Nm) AND THAT THE RUBBERS ARE CORRECTLY POSITIONED ON THE CARRIER.

F INSTRUCTIONS DE MONTAGE

1. ENLEVER LES CAOUTCHOUCS D'ORIGINE COMME INDICÉ EN PHOTO A
2. EXECUTER LE MONTAGE COMME INDICÉ EN PHOTO B
3. MONTER LA PLATINE DE FIXATION COMME INDICÉ EN PHOTO C
4. TERMINER LE MONTAGE EN CONTROLANT LE BON SERRAGE DE TOUTES LES VIS (VIS M6=9,6Nm - VIS M8=23Nm) ET LE BON MONTAGE DES SILENT BLOC SUR LA PLATINE.

D BAUANLEITUNG

1. DIE ORIGINALGUMMISTÖPSEL WIE IM BILD A ENTFERNEN;
2. DIE MONTAGE DURCHFÜHREN WIE IM BILD B DARGESTELLT;
3. DIE TRÄGERPLATTE WIE IM BILD C GEZEIGT MONTIEREN;
4. ZULETZT ÜBERPRÜFEN SIE DASS ALLE SCHRAUBEN (SCHRAUBEN M6=9,6NM - SCHRAUBEN M8=23NM) UND DIE STÖPSEL AUF DER PLATTE KORREKT MONTIERT SIND.

ES

INSTRUCCIONES DE MONTAJE

1. EXTRAER LAS GOMAS ORIGINALES INDICADAS EN LA IMAGEN A;
2. EFECTUAR EL MONTAJE COMO SE MUESTRA EN LA IMAGEN B;
3. COLOCAR LA PARRILLA PORTAEQUIPAJES COMO FIGURA EN LA IMAGEN C;
4. COMPLETAR EL MONTAJE ASEGURÁNDOSE DE QUE TODOS LOS TORNILLOS ESTAN BIEN APRETADOS (TORNILLOS M6=9,6Nm - TORNILLOS M8=23Nm) Y QUE LAS GOMAS ESTAN MONTADAS CORRECTAMENTE EN LA PARRILLA (NO INCLUIDA).