

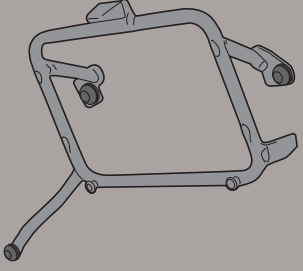

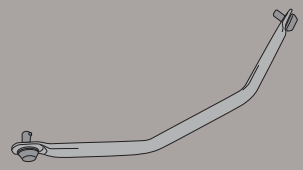
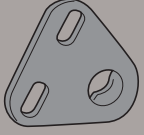
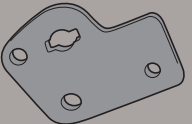
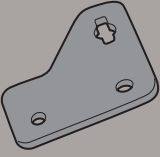

# PLR3105 - KLR3105

PORTAVALIGIE LATERALE SPECIFICO - SPECIFIC TUBULAR SIDE-CASE HOLDER - PORTE-VALISES LATÉRAUX SPÉCIFIQUE  
SPEZIFISCHES STAHLROHR-SEITENTRAEGER - PORTA MALETAS LATERALES ESPECÍFICO - TRONCO LADO ESPECÍFICO

## SUZUKI DL1000 V-STROM (2014)

N°	Descrizione	Caratteristiche	Codice	Quantità	
1	Supporto - Support - Support Halterung - Soporte - Apoio	-	PLR3105DXS PLR3105SXS	2 (Dx,Sx)	
2	Ponte Posteriore - Rear Bridge - Pont Postérieure Verbindungsrohr - Puente Trasero - Ponte Traseira	-	GNB1267P	1	
3	Supporto - Support - Support Halterung - Soporte - Apoio	-	GL2634R	2	
4	Supporto - Support - Support Halterung - Soporte - Apoio	-	GL2635DXR GL2635SXR	2 (Dx;Sx)	
5	Supporto - Support - Support Halterung - Soporte - Apoio	-	GL2637DXR GL2637SXR	2 (Dx;Sx)	
6	Vite - Screw Vis - Schraube Tornillo - Parafuso	TECF M6x40	640TECF	8	
7	Vite - Screw Vis - Schraube Tornillo - Parafuso	TBEI M8x25	825TBEI	4	
8	Distanziale - Spacer Entretoise - Distanzstueck Distanciador - Espaçador	Ø12x25 Foro 6,5mm	C12L25F6,5T	4	
9	Distanziale - Spacer Entretoise - Distanzstueck Distanciador - Espaçador	Ø12x20 Foro 6,5mm	C12L20F6,5T	4	

# PLR3105 - KLR3105

PORTAVALIGIE LATERALE SPECIFICO - SPECIFIC TUBULAR SIDE-CASE HOLDER - PORTE-VALISES LATÉRAUX SPÉCIFIQUE  
 SPEZIFISCHES STAHLROHR-SEITENTRAEGER - PORTA MALETAS LATERALES ESPECÍFICO - TRONCO LADO ESPECÍFICO

## SUZUKI DL1000 V-STROM (2014)

N°	Descrizione	Caratteristiche	Codice	Quantità	
10	Rondella - Washer Rondelle - Scheibe Arandela - Arruela	Ø8	814RON	4	
11	Dado - Bolt - Ecrou Mutter - Tuerca - Porca	Dado Auto Bloccante Flangiato M8	8DADIAFLN	4	
12	Chiave Per Viti A Testa Speciale - Special Key Cle Speciale - Spezialschlüssel Llave Para Tornillos Con Cabeza Especial	-	-	1	
13	Vite - Screw Vis - Schraube Tornillo - Parafuso	TBEI M6x60	660TBEI	2	
14	Rondella - Washer Rondelle - Scheibe Arandela - Arruela	Ø6	6RON	2	

GL2634

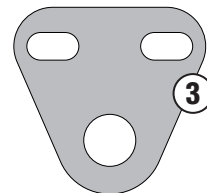

GL2635

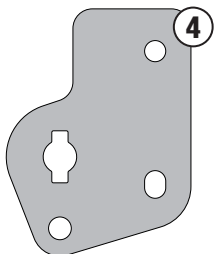

Ant. Sx

GL2637

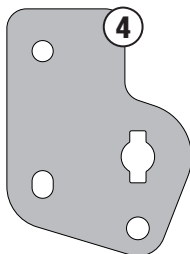

Ant. Dx

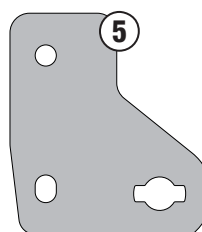

Post. Sx

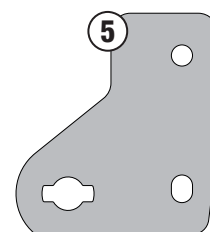

Post. Dx

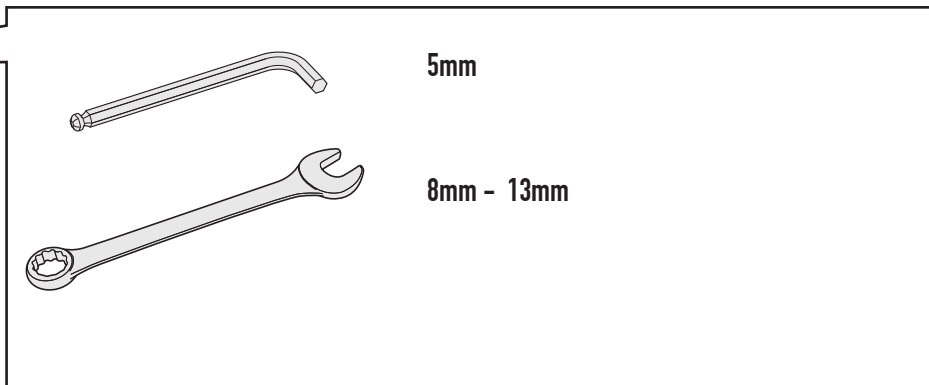
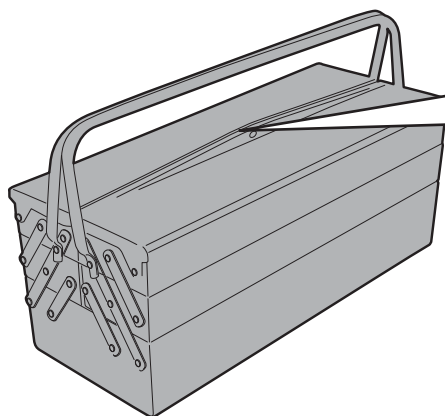

5mm

8mm - 13mm



ISTRUZIONI DI MONTAGGIO - MOUNTING INSTRUCTIONS  
 INSTRUCTIONS DE MONTAGE - BAUANLEITUNG  
 INSTRUCCIONES DE MONTAJE - INSTRUÇÕES DE MONTAGEM

# PLR3105 - KLR3105

PORTAVALIGIE LATERALE SPECIFICO - SPECIFIC TUBULAR SIDE-CASE HOLDER - PORTE-VALISES LATÉRAUX SPÉCIFIQUE  
SPEZIFISCHES STAHLROHR-SEITENTRAEGER - PORTA MALETAS LATERALES ESPECÍFICO - TRONCO LADO ESPECÍFICO

**SUZUKI DL1000 V-STROM (2014)**

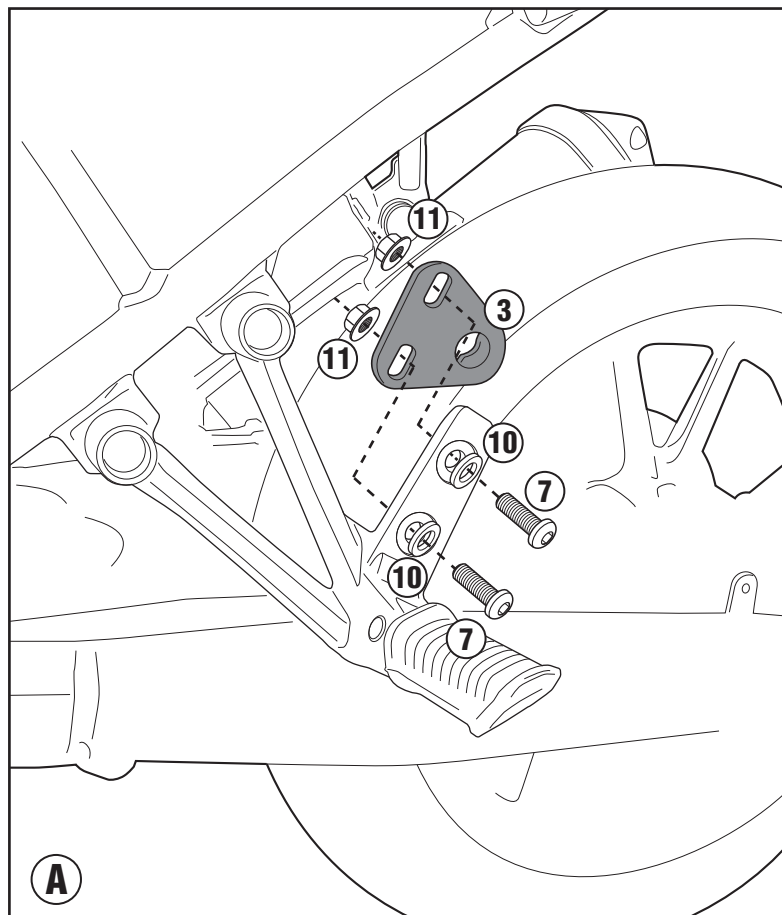
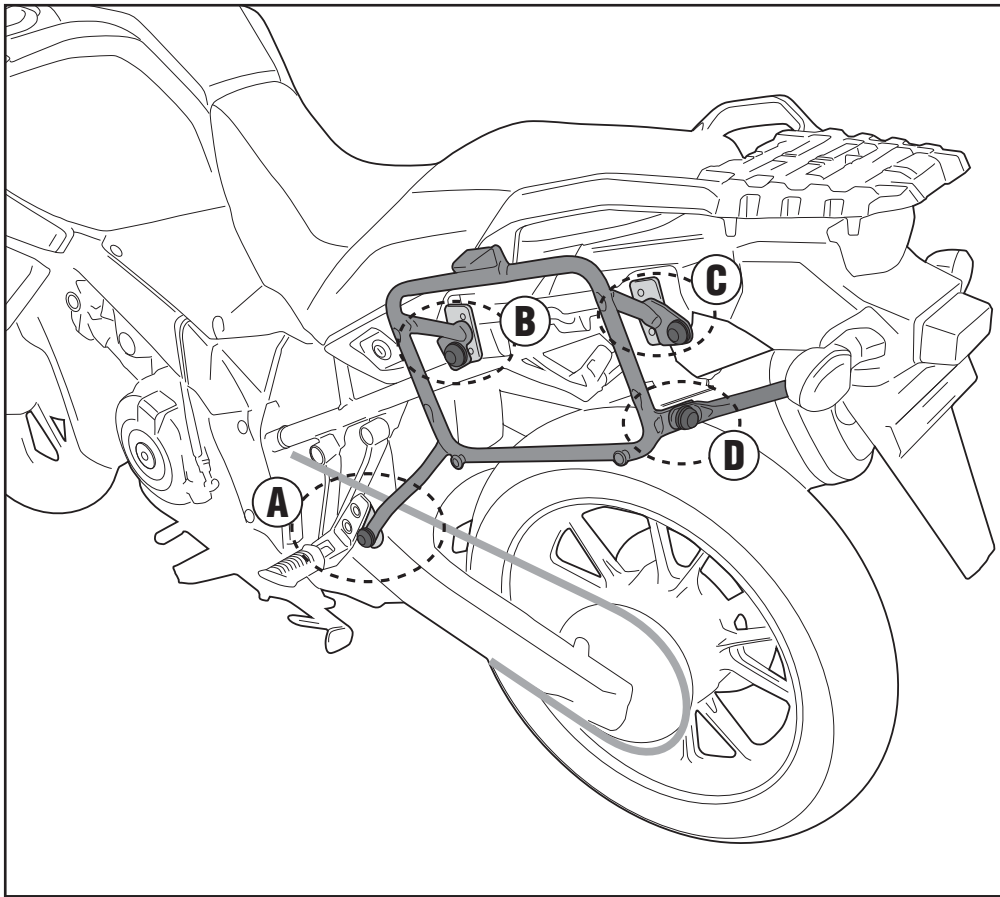

ISTRUZIONI DI MONTAGGIO - MOUNTING INSTRUCTIONS  
INSTRUCTIONS DE MONTAGE - BAUANLEITUNG  
INSTRUCCIONES DE MONTAJE - INSTRUÇÕES DE MONTAGEM

# PLR3105 - KLR3105

PORTAVALIGIE LATERALE SPECIFICO - SPECIFIC TUBULAR SIDE-CASE HOLDER - PORTE-VALISES LATÉRAUX SPÉCIFIQUE  
SPEZIFISCHES STAHLROHR-SEITENTRAEGER - PORTA MALETAS LATERALES ESPECÍFICO - TRONCO LADO ESPECÍFICO

**SUZUKI DL1000 V-STROM (2014)**

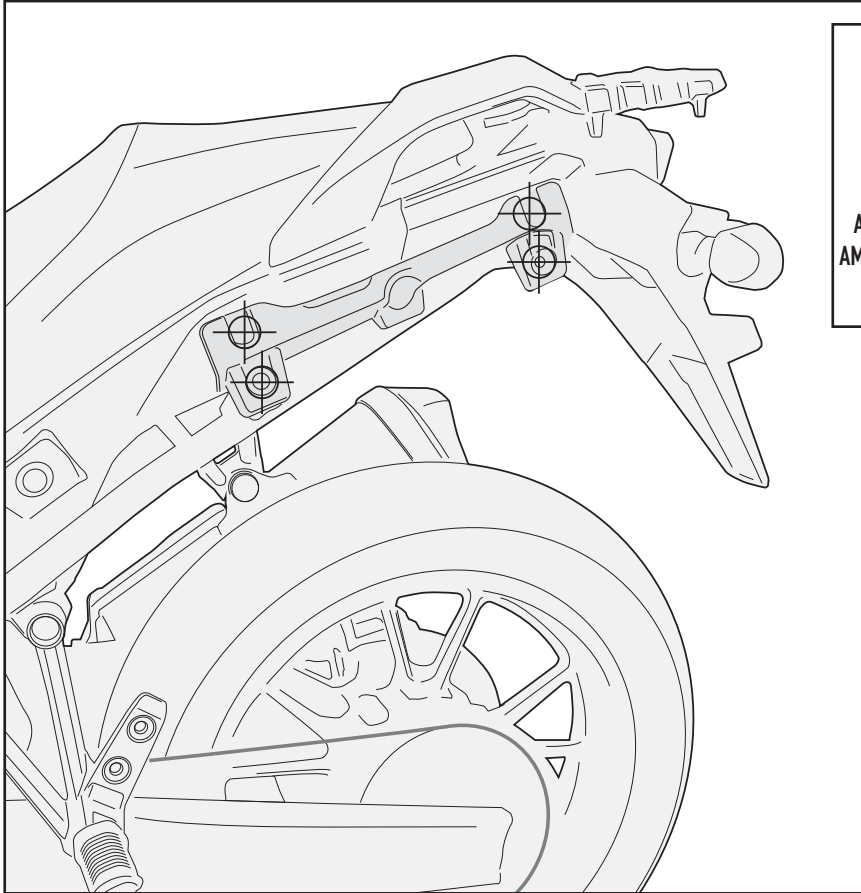

ALLARGARE I FORI CON UNA PUNTA DA 12MM  
ENLARGE THE HOLES WITH A Ø12 POINT  
AGGRANDIR LES TROUS AVEC UN FORET DE 12MM  
DIE LOCHER AUF 12MM AUFBOHREN  
AMPLIAR LOS AGUJEROS CON UNA PUNTA DE 12MM  
AMPLIAR AGUJERO COM UM POUCO DE 18 MILÍMETROS

**ONLY PLR3105**

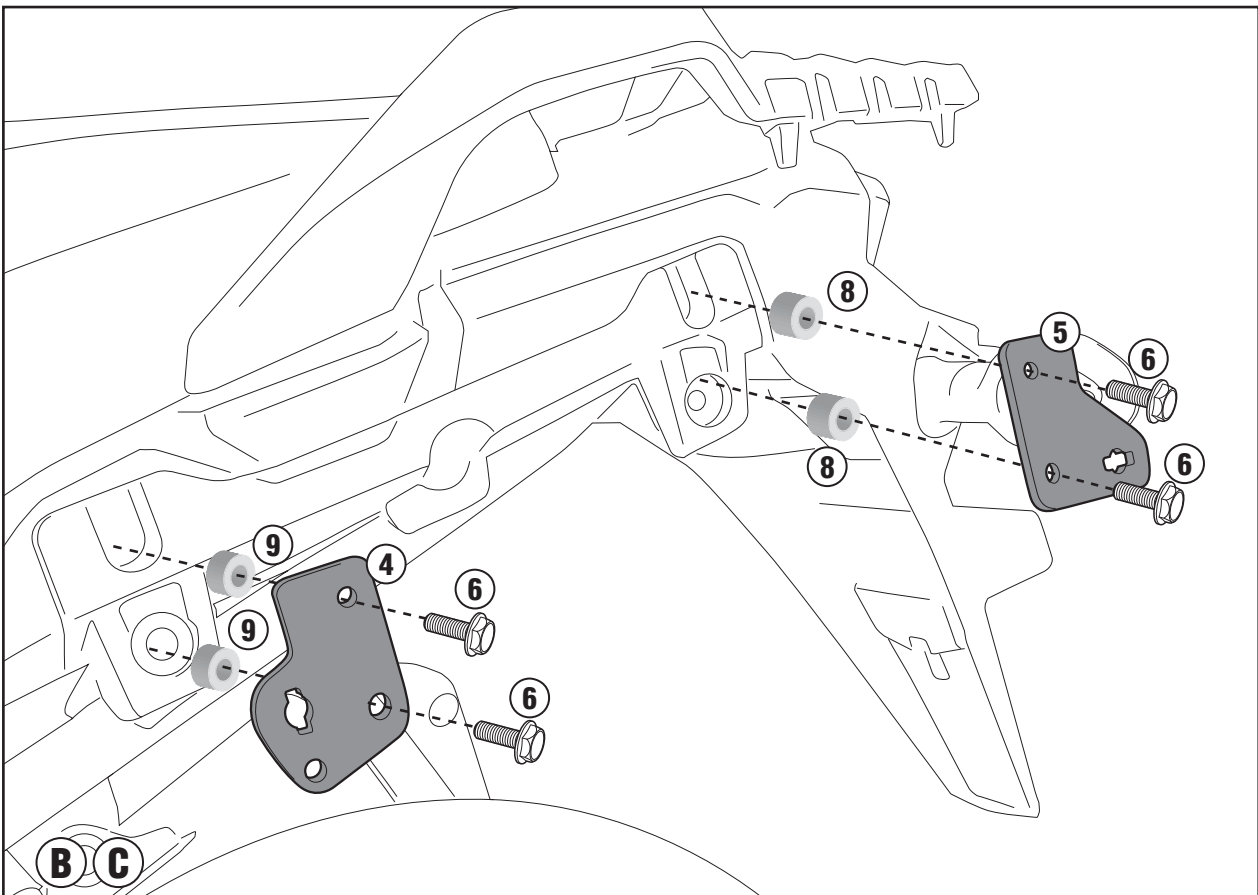

ISTRUZIONI DI MONTAGGIO - MOUNTING INSTRUCTIONS  
INSTRUCTIONS DE MONTAGE - BAUANLEITUNG  
INSTRUCCIONES DE MONTAJE - INSTRUÇÕES DE MONTAGEM

# PLR3105 - KLR3105

PORTAVALIGIE LATERALE SPECIFICO - SPECIFIC TUBULAR SIDE-CASE HOLDER - PORTE-VALISES LATÉRAUX SPÉCIFIQUE  
SPEZIFISCHES STAHLROHR-SEITENTRAEGER - PORTA MALETAS LATERALES ESPECÍFICO - TRONCO LADO ESPECÍFICO

**SUZUKI DL1000 V-STROM (2014)**

## PLR3105+SR3105/SRA3105/SR3105M

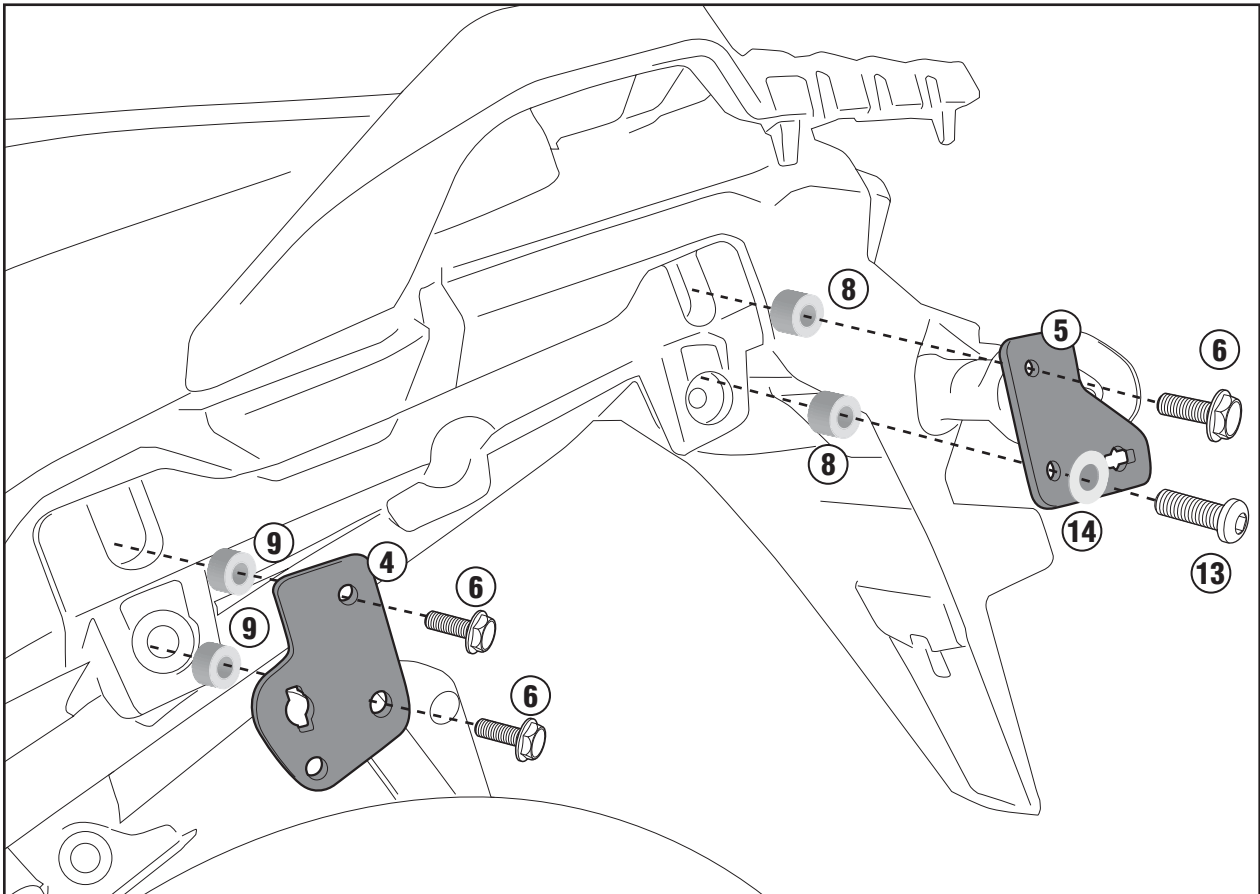

# PLR3105 - KLR3105

PORTAVALIGIE LATERALE SPECIFICO - SPECIFIC TUBULAR SIDE-CASE HOLDER - PORTE-VALISES LATÉRAUX SPÉCIFIQUE  
SPEZIFISCHES STAHLROHR-SEITENTRAEGER - PORTA MALETAS LATERALES ESPECÍFICO - TRONCO LADO ESPECÍFICO

**SUZUKI DL1000 V-STROM (2014)**

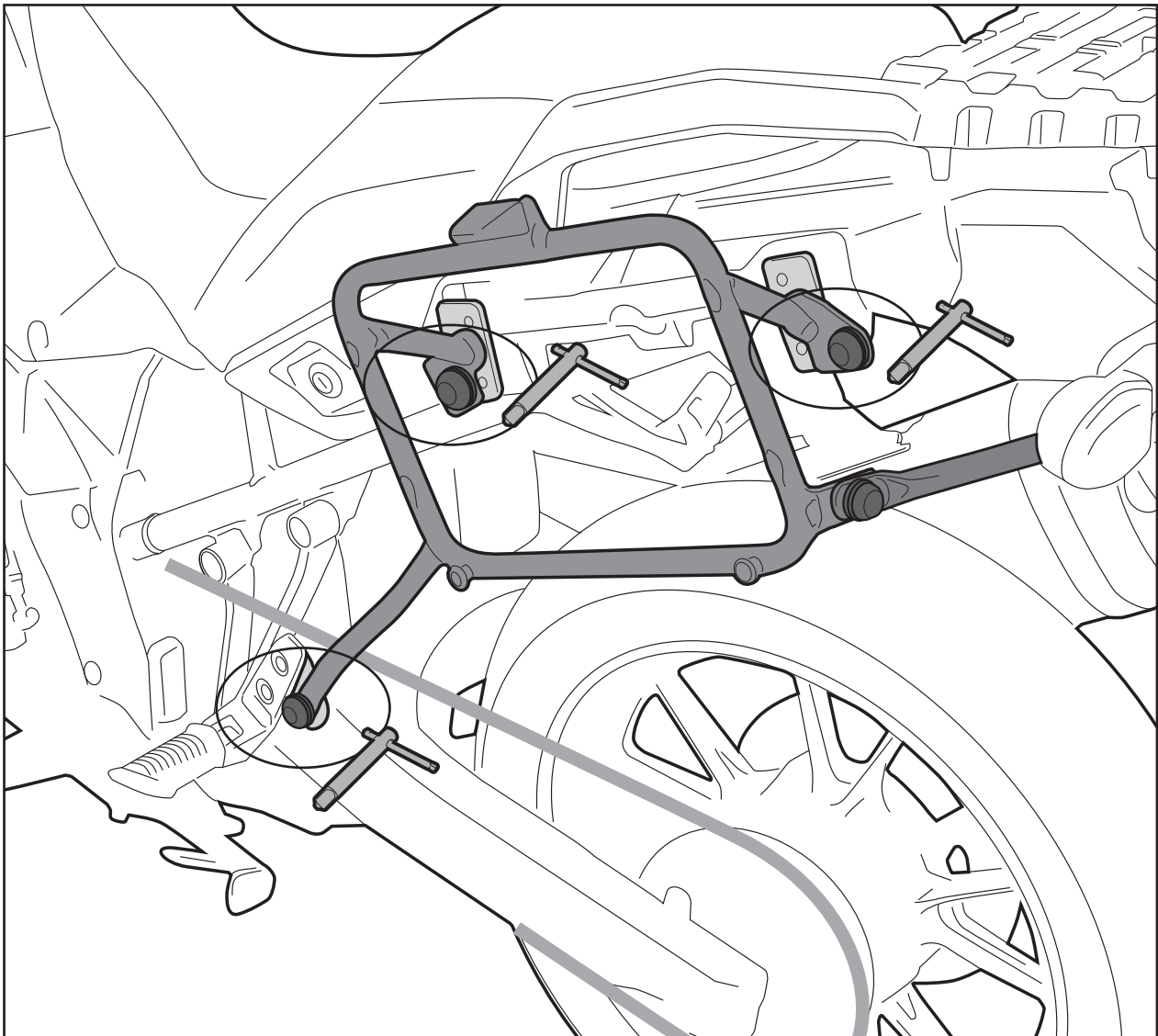
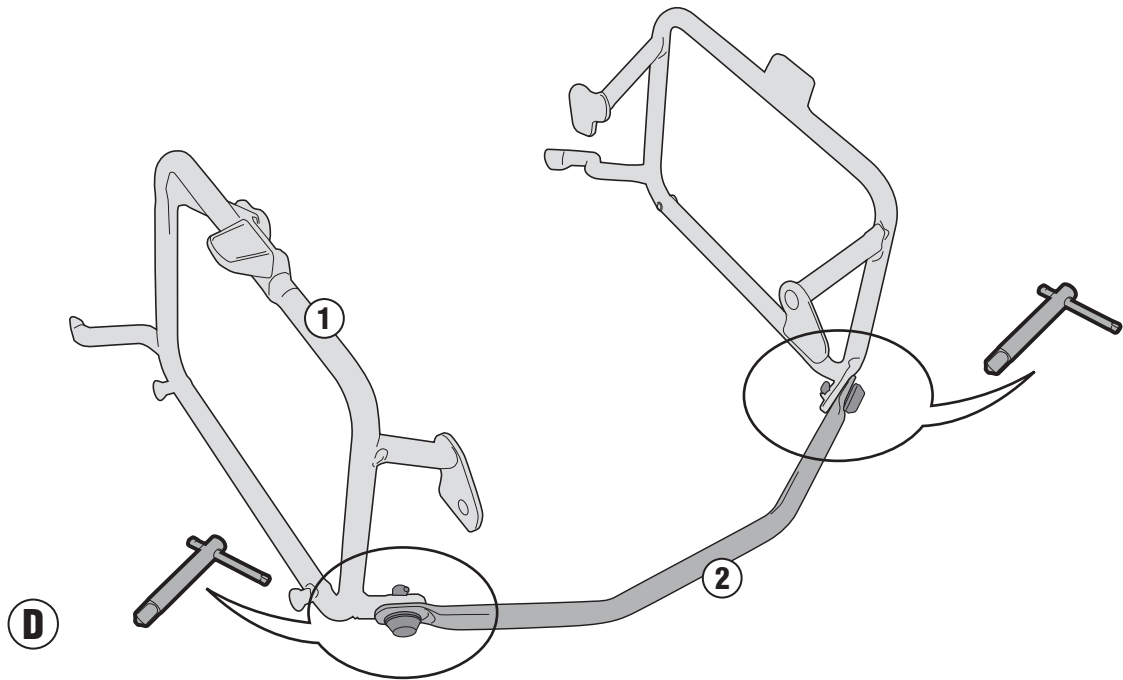

ISTRUZIONI DI MONTAGGIO - MOUNTING INSTRUCTIONS  
INSTRUCTIONS DE MONTAGE - BAUANLEITUNG  
INSTRUCCIONES DE MONTAJE - INSTRUÇÕES DE MONTAGEM

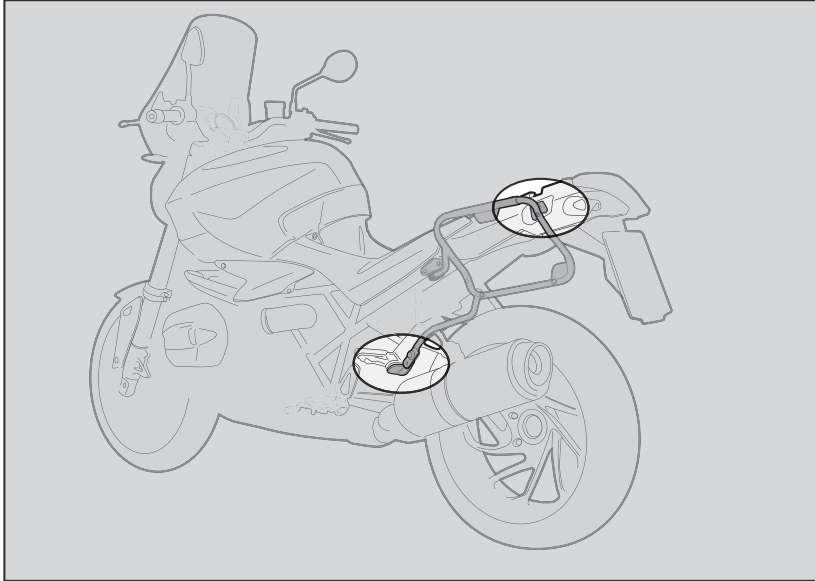

1. INSERIRE L'ATTREZZO NELLA TESTA DELLA VITE SPECIALE;
2. RUOTARE DI 1/4 DI GIRO IN SENSO ORARIO FINO A CHE LA ROTAZIONE NON TERMINA E SI AVVERTE LO SCATTO;
3. PER SMONTARE PROCEDERE IN SENSO INVERSO.

1. INSERT THE SPECIAL KEY INTO THE HEAD OF THE SCREW;
2. TURN THE KEY ¼ TURN CLOCKWISE UNTIL ROTATION STOPS AND THE SIDE CASE HOLDER IS FASTENED SECURELY TO THE FITMENT POINT;
3. IN ORDER TO DISASSEMBLE THE BRACKETRY PERFORM THE OPERATION IN REVERSE.

1. INSERER LA CLE SPECIALE DANS LA TETE DE LA VIS;
2. VISSER D'1/4 DE TOUR DANS LE SENS HORAIRE JUSQU'AU BLOCAGE DE LA VIS POUR MONTER EN TOUTE SECURITE LE SUPPORT A SON POINT DE FIXATION;
3. POUR LE DEMONTAGE, PROCEDER EN SENSE INVERSE.

1. STECKEN SIE DAS WERKZEUG IN DEN KOPF DER SPEZIFISCHEN SCHRAUBE;
2. DREHEN SIE DIE SCHRAUBE 1 / 4 UMDREHUNG IM UHRZEIGERSINN BIS SIE BEMERKEN, DASS DIE SCHRAUBE IM BEFESTIGUNGSPUNKT EINGEKLEMMT IST;
3. FÜR DIE DEMONTAGE FOLGEN SIE DEN HINWEISE UMGEKEHRT.

1. INSERTAR LA LLAVE ESPECIAL EN LA CABEZA DEL TORNILLO
2. DAR ¼ DE VUELTA EN EL SENTIDO HORARIO HASTA QUE LLEGUE AL TOPE Y SE VEA EL TORNILLO;
3. PARA DESMONTARLO PROCEDER EN LA DIRECCIÓN CONTRARIA;

**MONTAGGIO - ASSEMBLY - MONTAGE - MONTAGE - MONTAJE**

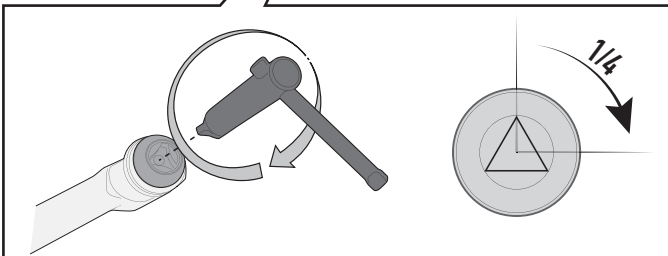
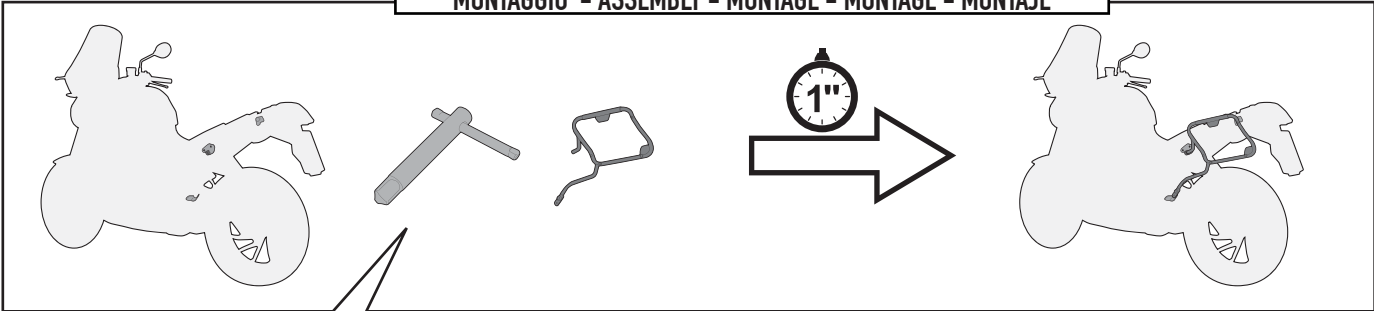

**SMONTAGGIO - DISASSEMBLY - DÉMONTAGE - DEMONTAGE - DESMONTAJE**

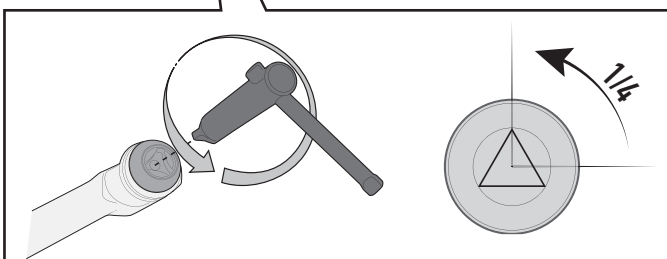
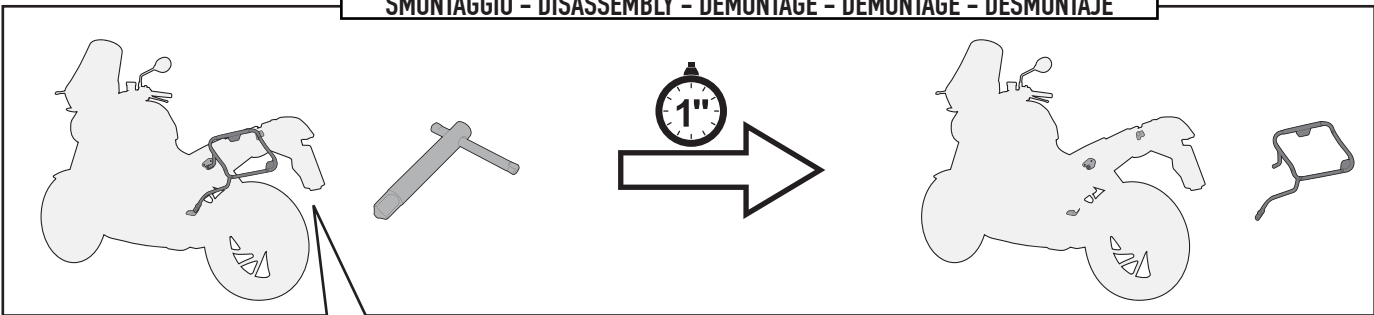

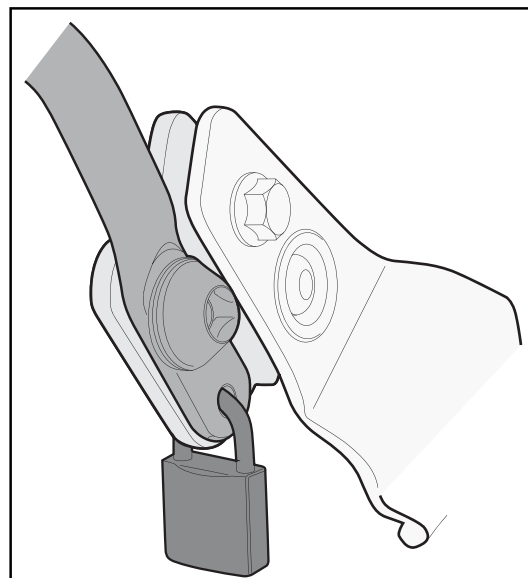
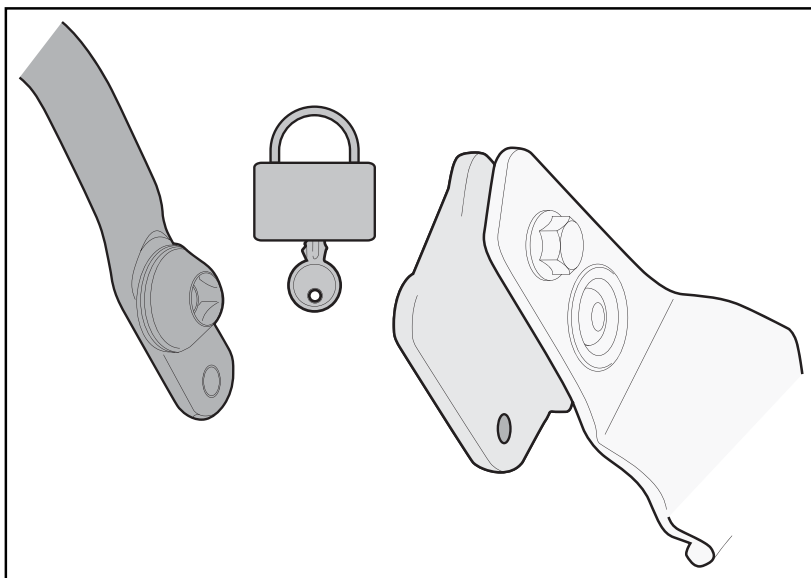
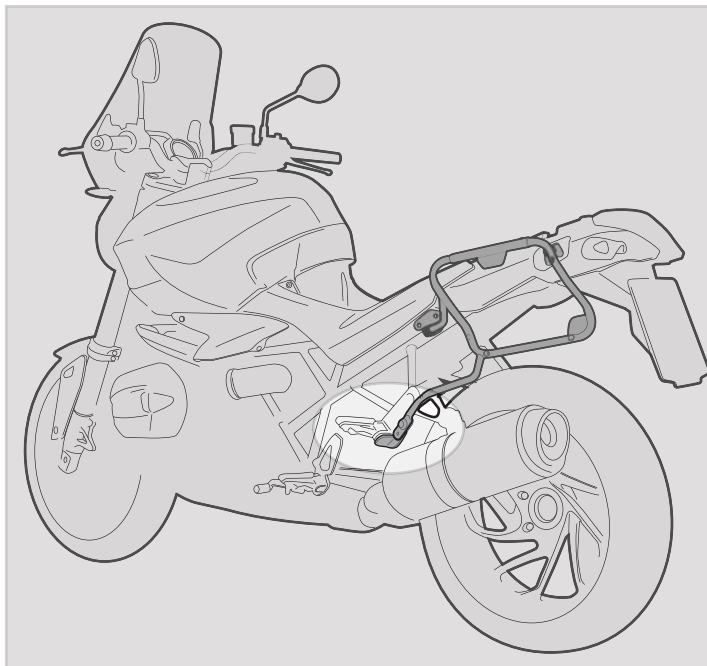

**FORO DI SICUREZZA**

FORO PREDISPOSTO AD ASSICURARE IL PORTAVALIGE LATERALE ALLA MOTO (CON UN LUCCHETTO PER ESEMPIO, NON INCLUSO).

**SECURITY HOLE**

HOLE PLACEMENT IN ORDER TO INCREASE SECURITY OF THE TUBULAR SIDE-CASE HOLDER TO THE MOTORCYCLE (WITH A LOCK, FOR EXAMPLE, NOT INCLUDED).

**TROU DE SECURITE**

TROU PREDISPOSE POUR ASSURER LE PORTE-VALISE LATERAL A LA MOTO (AVEC UN CADENAS PAR EXEMPLE, NON INCLUS).

**SICHERHEITSLÖCH**

VORGESEHENES LOCH UM DEN SEITENKOFFER TRÄGER AN DEM FAHRZEUG ZU SICHERN (Z. B. MIT EINEM VORHÄNGESCHLOSS, NICHT ENTHALTEN);

**ORIFICIO DE SEGURIDAD**

ESTE ORIFICIO ESTA CREADO PARA ASEGURAR EL PORTAEQUIPAJES LATERAL A LA MOTO (POR EJEMPLO CON UN CANDADO, QUE NO ESTÁ INCLUIDO).