

447FZ-KZ447

MONORACK SPECIFICO - SPECIFIC MONORACK
MONORACK SPECIFIQUE - SPEZIFISCHES MONORACK - MONORACK ESPECÍFICO

KAWASAKI VERSYS 06/08 650cc

ISTRUZIONI DI MONTAGGIO - MOUNTING INSTRUCTIONS
INSTRUCTIONS DE MONTAGE - BAUANLEITUNG - INSTRUCCIONES DE MONTAJE

①



SUPPORTO
SUPPORT
SUPPORT
HALTERUNG
SOPORTE

Q.TY n.2(Dx-Sx)

②



SUPPORTO
SUPPORT
SUPPORT
HALTERUNG
SOPORTE

Q.TY n.2(Dx-Sx)

③



SUPPORTO
SUPPORT
SUPPORT
HALTERUNG
SOPORTE

Q.TY n.2(Dx-Sx)

④



MOUSSE PROTETTIVA
Z1639DX e Z1639SX
PROTECTIVE RUBBER PADS
MOUSSE DE PROTECTION
SCHUTZGUMMI
ESPIUMA ADHESIVA
PROTECTORA

Q.TY n.2

⑤



VITE TCEI M8x25mm
Nere
SCREW M8x25mm
VIS M8x25mm
SCHRAUBE M8x25mm
TORNILLO M8x25mm

Q.TY n.2

⑥

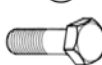

VITE TE M8x20mm
Flangiate Nere
SCREW M8x20mm
VIS M8x20mm
SCHRAUBE M8x20mm
TORNILLO M8x20mm

Q.TY n.2

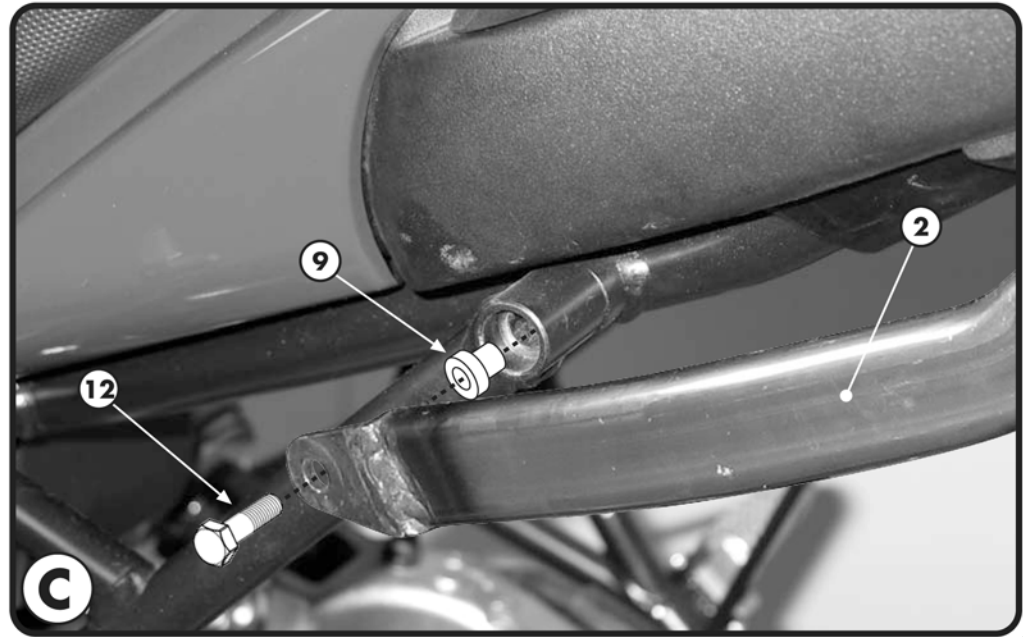
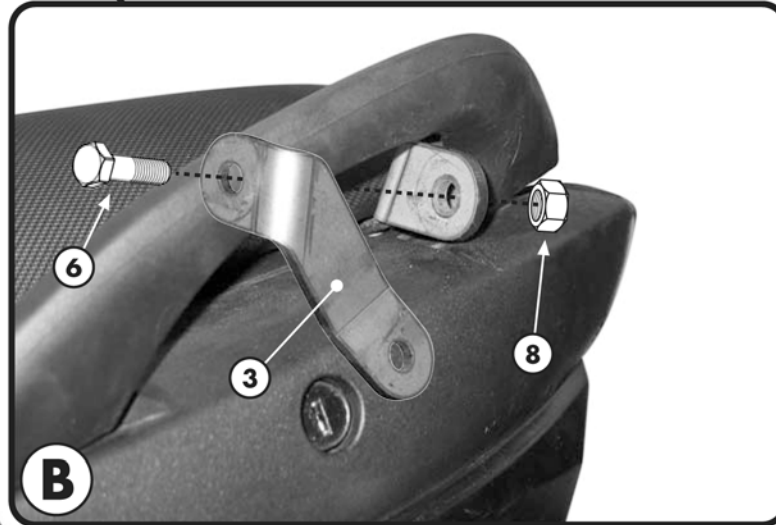
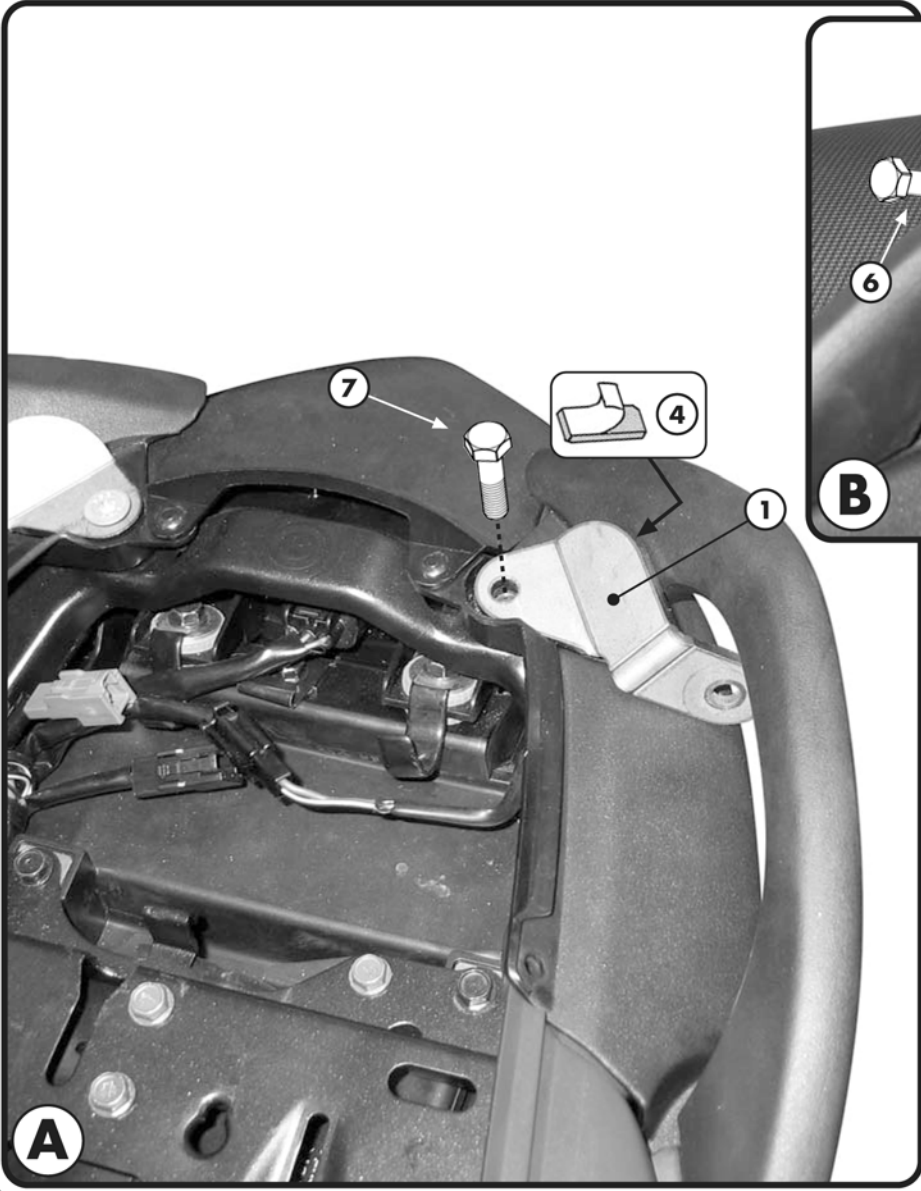

ATTENZIONE
PESO MASSIMO SOPPORTABILE 10Kg.

WARNING
MAX. LOADING OF THE CARRIER
10Kg.(21lbs)

ATTENTION
CHARGE MAXIMALE 10Kg.

ACHTUNG
MAXIMALE BELASTUNG 10Kg.

¡ATENCIÓN!
CARGA MÁXIMA AUTORIZADA 10Kg.

MONORACK SPECIFICO - SPECIFIC MONORACK
MONORACK SPECIFIQUE - SPEZIFISCHES MONORACK - MONORACK ESPECÍFICO

KAWASAKI VERSYS 06/08

650cc

ISTRUZIONI DI MONTAGGIO - MOUNTING INSTRUCTIONS
INSTRUCTIONS DE MONTAGE - BAUANLEITUNG - INSTRUCCIONES DE MONTAJE

7

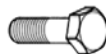

VITE TE M8x30mm
Flangiate Nere
SCREW M8x30mm
VIS M8x30mm
SCHRAUBE M8x30mm
TORNILLO M8x30mm

Q.TY n.2

8



DADO A.B. M8
Flangiate Neri
BOLT M8
ECROU M8
MUTTER M8
TUERCA M8

Q.TY n.4

9



DISTANZIALE Ø18x14mm
Ribassato Ø13x9mm
foro Ø8,5mm V526
SPACER
ENTRETOISE
DISTANZSTÜCK
DISTANCIADOR

Q.TY n. 2

10



COPRIVITE Ø8mm
Z801
SCREW CAP
CACHE VIS
STOPSSCHRAUBE
TAPA TORNILLO

Q.TY n.2

11

COMPONENTI ORIGINALI
ORIGINAL PARTS
PARTES ORIGINALES
ORIGINALBAUTEILE
COMPONENTES ORIGINALES

Q.TY n.-

12

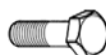

VITE TE M8x45mm
Flangiate Nere
SCREW M8x45mm
VIS M8x45mm
SCHRAUBE M8x45mm
TORNILLO M8x45mm

Q.TY n.2

13

PARTICOLARI INCLUSI NEL KIT VITERIA DELLA PIASTRA
COMPONENTS INCLUDED IN THE FITTING KIT OF THE PLATE
PIÈCES INCLUES DANS LE KIT DE VIS DE LA PLATINE
DIE EINZELNEN TEILE SIND BEI MONTAGEKIT DER PLATTE ENTHALTEN
DESPIECES INCLUIDOS EN EL KIT DE ANCLAJES DE LA PARRILLA

Q.TY n.-

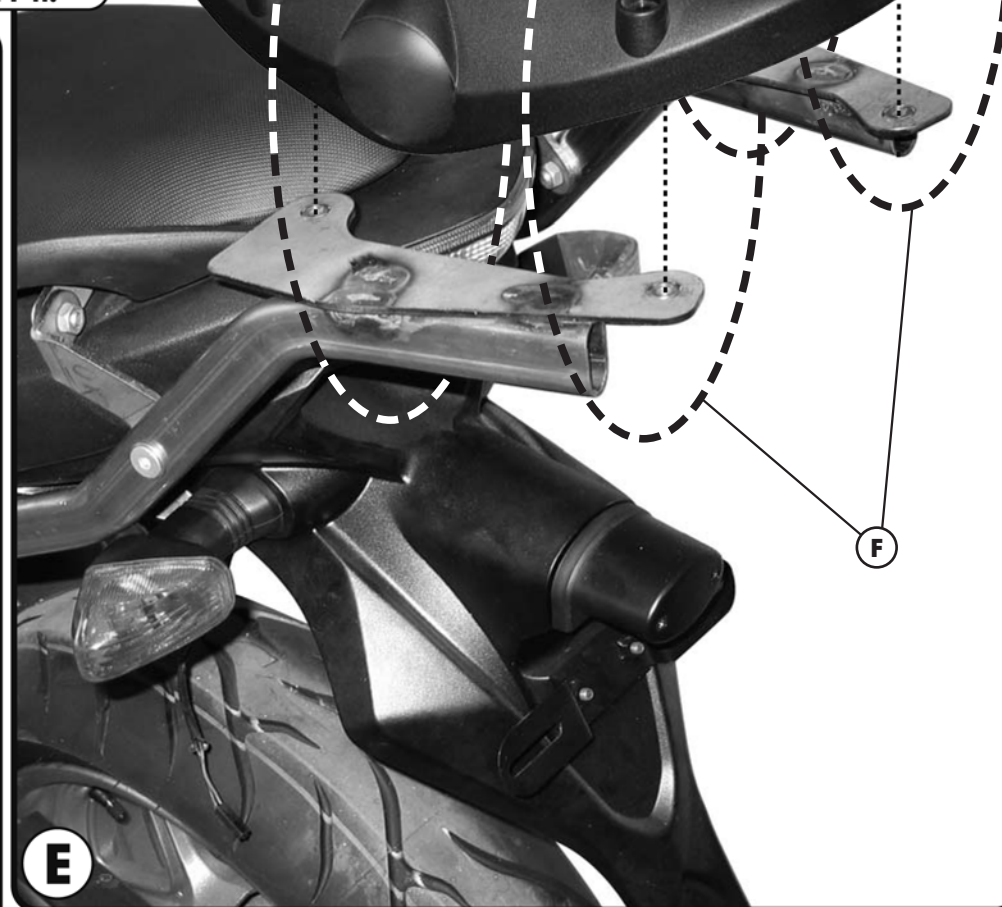

MONORACK SPECIFICO - SPECIFIC MONORACK
 MONORACK SPECIFIQUE - SPEZIFISCHES MONORACK - MONORACK ESPECÉFICO

KAWASAKI VERSYS 06/08

650cc

ISTRUZIONI DI MONTAGGIO - MOUNTING INSTRUCTIONS
 INSTRUCTIONS DE MONTAGE - BAUANLEITUNG - INSTRUCCIONES DE MONTAJE

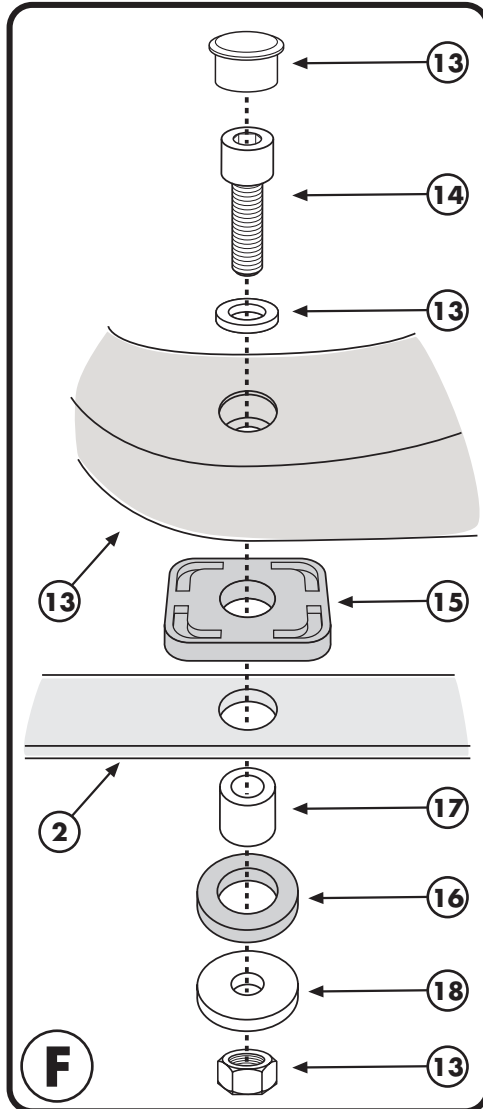

14



VITE TCEI M6x35mm
 SCREW
 VIS
 SCHRAUBE
 TORNILLO

Q.TY n.4

15

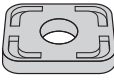

GOMMINO
 Z1822
 RUBBER
 CAOUTCHOUC
 GUMMI
 GOMA

Q.TY n.4

16



RONDELLA IN GOMMA
 Z1823
 RUBBER WASHER
 RONDELLE EN GOMME
 GUMMISCHEIBE
 ARANDELA DE GOMA

Q.TY n.4

17



DISTANZIALE f11x11mm
 foro f6,5mm
 V687
 SPACER
 ENTRETISE
 DISTANZSTUECK
 DISTANCIADOR

Q.TY n. 4

18



RONDELLA f16x20mm
 WASHER
 RONDELLE
 SCHEIBE
 ARANDELA

Q.TY n.4

MONORACK SPECIFICO - SPECIFIC MONORACK
MONORACK SPECIFIQUE - SPEZIFISCHES MONORACK - MONORACK ESPECÍFICO

KAWASAKI VERSYS 06/08
650cc

ISTRUZIONI DI MONTAGGIO - MOUNTING INSTRUCTIONS
INSTRUCTIONS DE MONTAGE - BAUANLEITUNG - INSTRUCCIONES DE MONTAJE

I ISTRUZIONI DI MONTAGGIO

1. MONTARE I SUPPORTI N°1, FOTOGRAFIA A; APPLICARE LA MUOSSE ADESIVA, PARTICOLARE N°4, COME INDICATO IN FOTOGRAFIA A;
2. MONTARE IL SUPPORTO N°3 COME INDICATO IN FOTOGRAFIA B;
3. MONTARE IL SUPPORTO MONORACK, PARTICOLARE N°2, COME INDICATO NELLE FOTOGRAFIE C E D;
4. FISSARE LA PIASTRA PORTAVALIGIA (NON INCLUSA) COME ILLUSTRATO IN FOTOGRAFIA E;
5. ULTIMARE IL MONTAGGIO CONTROLLANDO CHE TUTTE LE VITI SIANO SERRATE BENE.

GB MOUNTING INSTRUCTIONS

1. MOUNT THE SUPPORTS N° 1, PICTURE A; STICK THE PROTECTIVE RUBBER PAD, N° 4, AS SHOWN IN PICTURE A;
2. MOUNT THE SUPPORT N° 3 AS SHOWN IN PICTURE B;
3. MOUNT THE MONORACK, PART N° 2, AS SHOWN IN THE PICTURES C AND D;
4. FIX THE TOP-CASE PLATE (NOT INCLUDED) AS SHOWN IN PICTURE E;
5. LASTLY CHECK THAT ALL SCREWS HAVE BEEN TIGHTENED.

F INSTRUCTIONS DE MONTAGE

1. MONTER LE SUPPORT N.1, PHOTO A; APPLIQUER LA MOUSSE AUTOCOLLANTE, DETAIL N.4, COMME INDIQUE EN PHOTO A;
2. MONTER LE SUPPORT N.3 COMME INDIQUE EN PHOTO B;
3. MONTER LE MONORACK, DETAIL N.2, COMME INDIQUE PAR LES PHOTOS C ET D;
4. FIXER LA PLATINE PORTE VALISE (PAS INCLUSE) COMME INDIQUE EN PHOTO E;
5. TERMINER LE MONTAGE EN CONTROLANT LE BON SERRAGE DE TOUTES LES VIS.

D BAUANLEITUNG

1. MONTIEREN SIE DIE HALTERUNGEN NR. 1, BILD A; BEFESTIGEN SIE DIE SCHUTZGUMMI N° 4, WIE IM BILD A BESCHRIEBEN;
2. MONTIEREN SIE DIE HALTERUNG NR. 3 WIE IM BILD B BESCHRIEBEN;
3. MONTIEREN SIE DIE MONORACK ARME, TEIL NR. 2, WIE IN DEN BILDERN C UND D BESCHRIEBEN;
4. BEFESTIGEN SIE DIE PLATTE (NICHT VORHANDEN) WIE IM BILD E BESCHRIEBEN;
5. ZULETZT ÜBERPRÜFEN SIE, DASS ALLE SCHRAUBEN FESTGEZOGEN WURDEN.

ES

INSTRUCCIONES DE MONTAJE

1. MONTAR EL SOPORTE N° 1, IMAGEN A, APLICAR EL PEGAMENTO, ARTICULO N°4, TAL Y COMO SE INDICA EN LA IMAGEN A.
2. MONTAR EL SOPORTE N° 3 TAL Y COMO SE INDICA EN LA IMAGEN B;
3. MONTAR EL SOPORTE MONORACK, ARTICULO N°2, TAL Y COMO SE INDICA EN LA IMAGEN C Y D.
4. FIJAR LA PARRILLA PORTAEQUIPAJES (NO INCLUIDA) TAL Y COMO SE ILUSTRAN EN LA FOTOGRAFIA E;
5. FINALIZAR EL MONTAJE ASEGURANDOSE QUE TODOS LOS TRONILLOS HAN SIDO APRETADOS CORRECTAMENTE.