



ATTACCHI SPECIFICI PER - SPECIFIC FITTING KIT FOR
 KIT DE MONTAGE SPECIFIQUE POUR - SPEZIFISCHER MONTAGEKIT FÜR
 ANCLAJE ESPECÍFICO PARA

KYMCO AGILITY R16 50-125-150cc
 2008 - 2009

ISTRUZIONI DI MONTAGGIO - MOUNTING INSTRUCTIONS
 INSTRUCTIONS DE MONTAGE - BAUANLEITUNG - INSTRUCCIONES DE MONTAJE

1

SUPPORTO
 SUPPORT
 SUPPORT
 HALTERUNG
 SOPORTE
Q.TY n.2(Dx-Sx)

2

SUPPORTO
 SUPPORT
 SUPPORT
 HALTERUNG
 SOPORTE
Q.TY n.2(Dx-Sx)

3

VITE TEF M8x40mm
 SCREW
 VIS
 SCHRAUBE
 TORNILLO
Q.TY n.2

4

VITE TBEI M6x25mm
 SCREW
 VIS
 SCHRAUBE
 TORNILLO
Q.TY n.4

5

RONDELLA Ø8mm
 WASHER Ø8mm
 RONDELLE Ø8mm
 SCHEIBE Ø8mm
 ARANDELA Ø8mm
Q.TY n.2

6

DISTANZIALE Ø14x25mm
 Foro Ø10mm, V599
 SPACER
 ENTRETOISE
 DISTANZSTÜCK
 DISTANCIADOR
Q.TY n.2

7

BOCCOLA DI RITENZIONE Z871N
 PLASTIC BUSH
 DOUILLE PLASTIQUE
 PLASTIK BUCHSE
 CASQUILLO
Q.TY n.4

8

GOMMINO Z268
 FAIRLEADER
 CHAUMARD
 GUMMI
 GOMA
Q.TY n.4

9

DADO A.B. M6
 FLANGIATO
 BOLT M6
 ECROU M6
 MUTTER M6
 TUERCA M6
Q.TY n.4

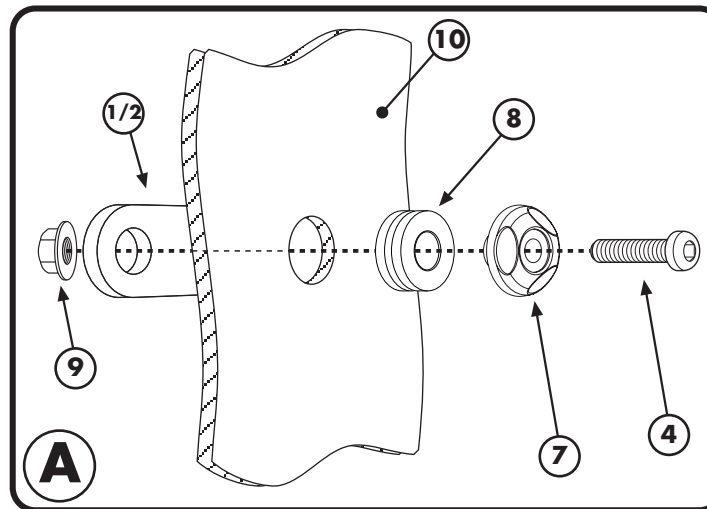
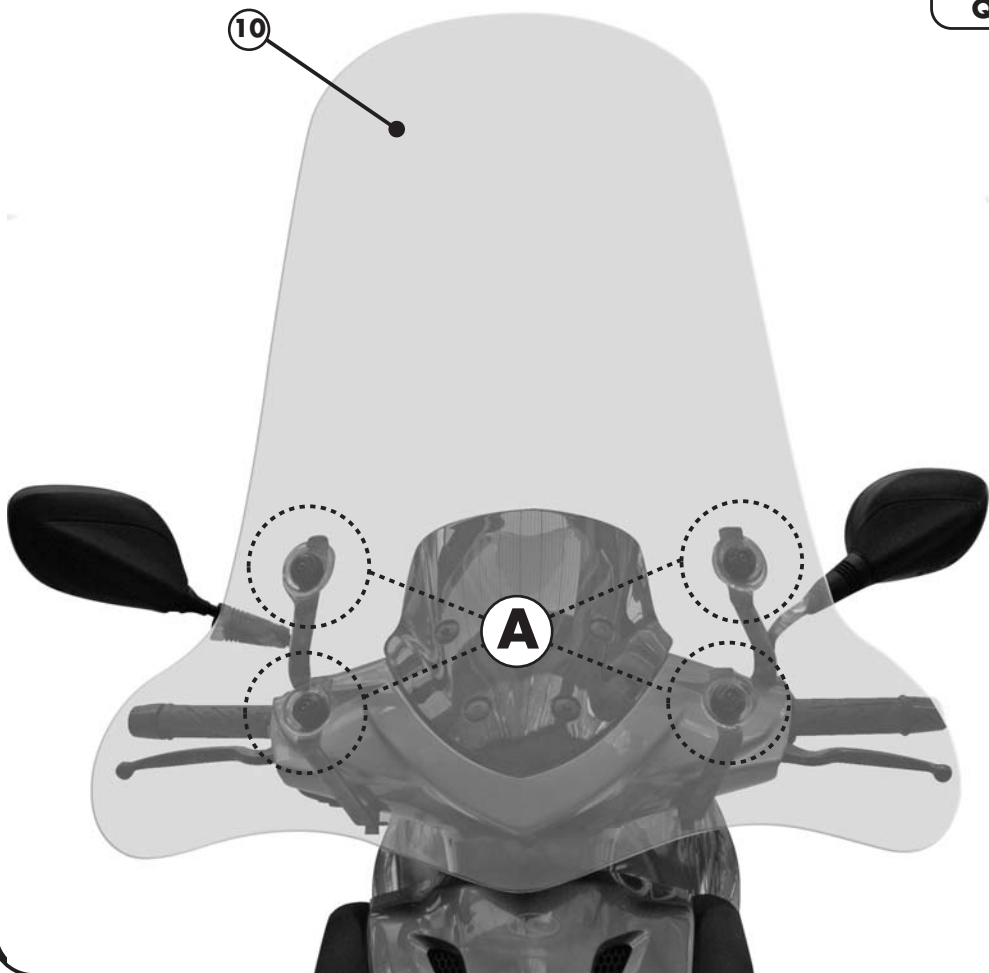
10

NON INCLUSO
 NOT INCLUDED
 PAS INCLUIS
 NICHT INKLUDIERT
 NO ESTÁ INCLUIDO



ATTACCHI SPECIFICI PER - SPECIFIC FITTING KIT FOR
KIT DE MONTAGE SPECIFIQUE POUR - SPEZIFISCHER MONTAGEKIT FÜR
ANCLAJE ESPECÍFICO PARA

KYMCO AGILITY R16 50-125-150cc
2008 - 2009

ISTRUZIONI DI MONTAGGIO - MOUNTING INSTRUCTIONS
INSTRUCCIONES DE MONTAJE - BAUANLEITUNG - INSTRUCCIONES DE MONTAJE

