















TE4104 - TE4104K

TELAIETTO LATERALE SPECIFICO - SPECIFIC SADDLEBAG TUBULAR HOLDER - SUPPORT TUBULAIRE POUR SACOCHES CAVALIÈRES - SPEZIAL SEITENTRAEGER FUER WEICHTASCHEN
PORTA ALFORJAS TUBULAR LATERAL

KAWASAKI ER-6n/ER-6f 2012

N°	Descrizione	Caratteristiche	Codice	Quantità	
1	Supporto - Support - Support Halterung - Soporte		-	2 (Dx,Sx)	
2	Rear Bridge Pont Posterieure - Verbindungsrohr Puente Trasero		-	1	
3	Supporto Freccia- Blinker Support Support Clignotant - Blinker Halter - Soporte Intermitente		GL1129	2 (Dx,Sx)	
4	Supporto - Blinker Support Support - Halter - Soporte		GL2066	2	
5	Supporto - Blinker Support Support - Halter - Soporte		GL1462	2	
6	Supporto - Blinker Support Support - Halter - Soporte		GL1461	2	
7	Vite - Screw Vis - Schraube Tornillo	TCEI M8x50	-	2	
8	Vite - Screw Vis - Schraube Tornillo	TEF M6x16		6	
9	Vite - Screw Vis - Schraube Tornillo	TEF M8x20		2	
10	Vite - Screw Vis - Schraube Tornillo	TEF M8x50		2	
11	Dado - Bolt - Ecrou Mutter - Tuerca	Auto Bloccante Flangiato M8		2	
12	Dado - Bolt - Ecrou Mutter - Tuerca	Auto Bloccante Flangiato M6		2	
13	Dado - Bolt - Ecrou Mutter - Tuerca	Auto Bloccante Flangiato Ribassato M6		4	
14	Distanziale - Spacer Entretoise - Distanzstueck Distanciador	Ø18x17 foro 8.5mm	V420	2	
15	Coprivite - Screw Cap Cache Vis - Stoppschraube Tapa Tornillo		Z801	2	

TE4104 - TE4104K

TELAIETTO LATERALE SPECIFICO - SPECIFIC SADDLEBAG TUBULAR HOLDER - SUPPORT TUBULAIRE POUR SACOCHES CAVALIÈRES - SPEZIAL SEITENTRAEGER FUER WEICHTASCHEN
PORTA ALFORJAS TUBULAR LATERAL

KAWASAKI ER-6n/ER-6f 2012

N°	Descrizione	Caratteristiche	Codice	Quantità
16	Sparticolari Inclusi Nel Kit Viteria Del Monorack Components Included In The Fitting Kit Of The Monorack Pièces Inclues Dans Le Kit De Vis De El Monorack Die Einzelnen Teile Sind Bei Montagekit Der Monorack Enthalten Despieces Incluidos En El Kit De Anclajes De El Monorack		-	-

TE4104 - TE4104K

TELAIETTO LATERALE SPECIFICO - SPECIFIC SADDLEBAG TUBULAR HOLDER - SUPPORT TUBULAIRE POUR SACOCHES CAVALIÈRES - SPEZIAL SEITENTRAEGER FUER WEICHTASCHEN
PORTA ALFORJAS TUBULAR LATERAL

KAWASAKI ER-6n/ER-6f 2012

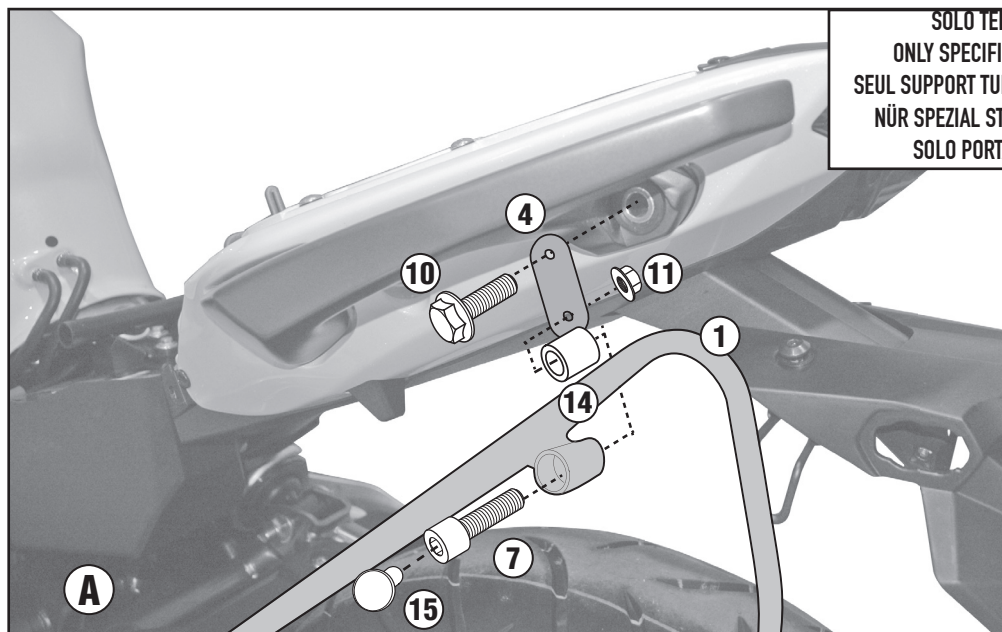
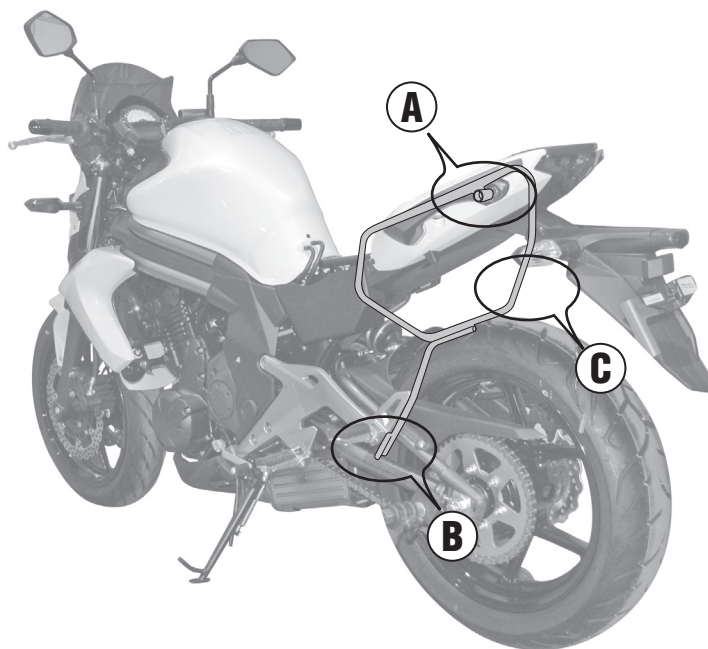

SOLO TELAIETTO LATERALE SPECIFICO
ONLY SPECIFIC SADDLEBAGS TUBULAR HOLDER
SEUL SUPPORT TUBULAIRE POUR SACOCHES CAVALIÈRES
NÜR SPEZIAL STAHLROHR-SEITENKOFFER-TRAEGER
SOLO PORTA ALFORJAS TUBULAR LATERAL

MONORACK SPECIFICO+TELAJETTO LATERALE SPECIFICO
SPECIFIC MONORACK+SPECIFIC SADDLEBAGS TUBULAR HOLDER
MONORACK SPECIFIQUE+SUPPORT TUBULAIRE POUR SACOCHES CAVALIÈRES
SPEZIFISCHES MONORACK+SPEZIAL STAHLROHR-SEITENKOFFER-TRAEGER
MONORACK ESPECÍFICO+PORTA ALFORJAS TUBULAR LATERAL

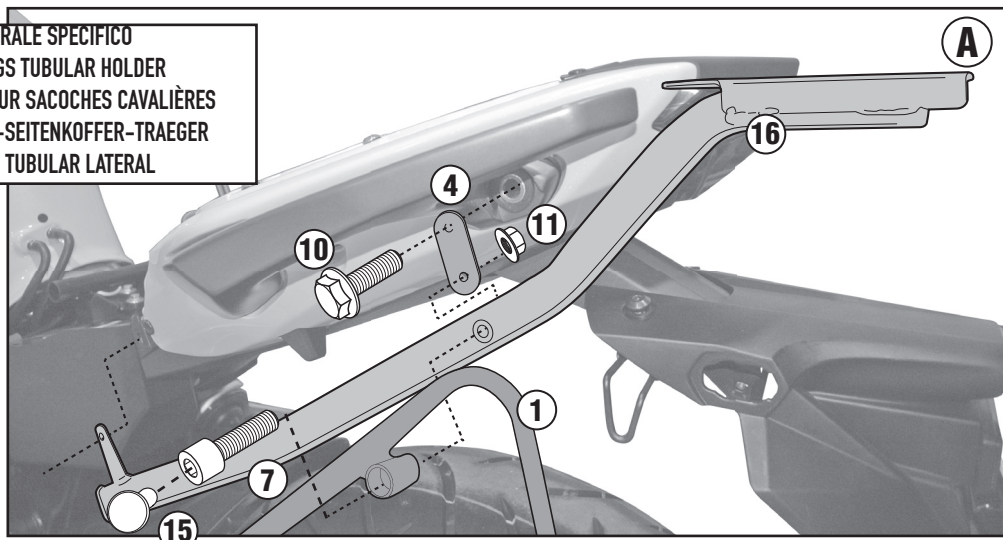

ISTRUZIONI DI MONTAGGIO - MOUNTING INSTRUCTIONS
INSTRUCTIONS DE MONTAGE - BAUANLEITUNG - INSTRUCCIONES
DE MONTAJE

TE4104 - TE4104K

TELAJETTO LATERALE SPECIFICO - SPECIFIC SADDLEBAG TUBULAR HOLDER - SUPPORT TUBULAIRE POUR SACOCHES CAVALIÈRES - SPEZIAL SEITENTRAEGER FUER WEICHTASCHEN
PORTA ALFORJAS TUBULAR LATERAL

KAWASAKI ER-6n/ER-6f 2012

