

Preparation

If the handlebar grips are not open at the end they will need to be cut open for the handguard to be fitted. Use a sharp knife to cut a hole in the end of each handgrip. On the right side the hole size should be neat and no smaller than the inside diameter of the throttle tube. Loosen the throttle assembly to move it outward about 20mm. Roll back the end of the grip and use a hacksaw to carefully cut off the end cap of the plastic throttle tube. Do not remove more than 3mm and take care not to cut the underlying handlebar. Before refitting, remove any burrs that could restrict throttle movement.

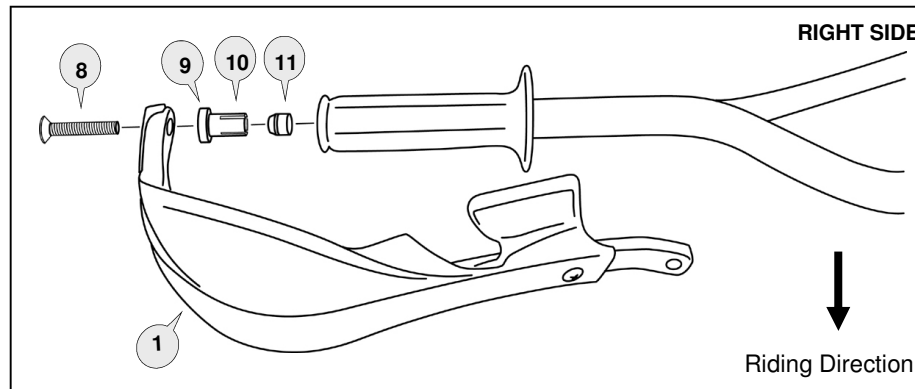
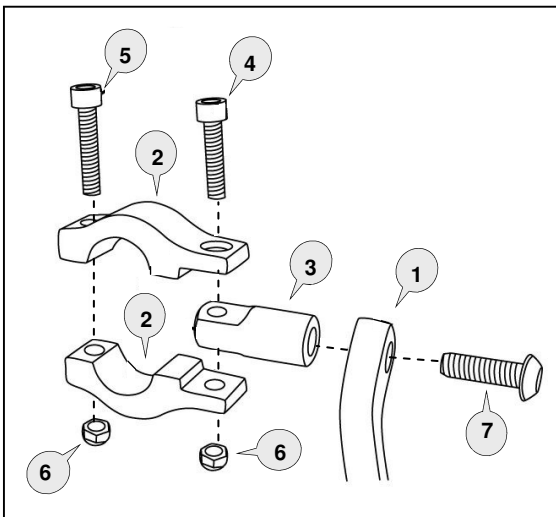

NOTE: for steel bars, use collet (12) over the top of expander (10).

Important Fitting Procedure

Loosely assemble the clamp to the handlebar as per diagram. Attach the handguard with applicable parts to the handlebar end and also to the clamp connector (3).

Position backbone so it is horizontal when viewed from the side and tighten bolt (8).

The clamp bolts must be tightened in the following order:

Tighten bolt (7) through the aluminium bar (1) to the clamp connector (3) of the clamp assembly.

Tighten bolt (4) to solidly lock the swivel section (3) between the clamp saddles (2).













Tighten bolt (5) to secure the clamp assembly firmly to the handlebar.

Note: The clamp is designed to allow the nut on bolt (4) to pull into the recessed hole. This eliminates the need for a wrench after the bolt starts to tighten.

Some handlebars may have a solid insert welded into the handlebar end. In this situation we recommend drilling and tapping to a M8x1.25mm thread.



Phone: +61 (0)2 4271 8244
Email: info@barkbusters.net

<p>1 Mini Aluminium Bar & Plastic</p>  <p>PN: EGO-HG-020 Pcs. 1 Left & 1 Right</p>	<p>2 Clamp Saddle</p>  <p>PN: CS-STD Pcs. 4 pieces</p>	<p>3 Swivel 45mm</p>  <p>PN: CP1 Pcs. 2</p>	<p>4 Socket Head Bolt 25mm</p>  <p>PN: M6x25SHCSZP Pcs. 2</p>	<p>5 Socket Head Bolt 30mm</p>  <p>PN: M6x30SHCSZP Pcs. 2</p>	<p>6 Nylock Nut</p>  <p>PN: M6LN Pcs. 4</p>	<p>7 Button Head Bolt 25mm</p>  <p>PN: M8x25BHCSZP Pcs. 2</p>	<p>8 Flat Head Bolt 45mm</p>  <p>PN: M8x45FHCSZP Pcs. 2</p>
<p>9 Collar</p>  <p>PN: BBEC5m Pcs. 2</p>	<p>10 Expander</p>  <p>PN: BBE14A Pcs. 2</p>	<p>11 Taper Nut</p>  <p>PN: NUT12 Pcs. 2</p>	<p>12 Collet</p>  <p>PN: COLLET14-18 Pcs. 2</p>				

CAUTION:

Installation of the handguard is safety-relevant work and can be complicated. We recommend the installation be performed by a motorcycle service technician. Rideworx accepts no liability for damages caused by improper mounting. All screws, bolts and nuts, including all replacement hardware provided by Rideworx, should be tightened to the torque specified in the below table. After the first 50km of riding check all screws, bolts and nuts are tightened to the correct torque. We recommend a medium strength liquid thread lock product on all fasteners.

WARNING:

It is important there is a working clearance (approx 3mm) between the throttle grip end and the handguard to ensure a free closing throttle. Check operation of all handlebar controls, specifically the throttle, front brake, kill switch and clutch to ensure they are operating correctly and are in accordance with the OEM specifications. Do not ride the motorcycle if any controls are not operating correctly. Check periodically that all bolts are tight.

Recommended Torque Settings	
M6	10 Nm (7.4 lbf ft)
M8	20 Nm (14.8 lbf ft)



Phone: +61 (0)2 4271 8244
Email: info@barkbusters.net
Web: www.barkbusters.net

Barkbusters

Disclaimer:

A failure to follow these fitting instructions could cause serious injury, death or property damage. These handguards are intended solely for use with motorcycles/ATV/snowmobiles/scooters that have not been modified. They are not designed to prevent injury or death while riding or in an accident or crash. The user must ensure that all controls are free of the handguards every time that they ride. By installing and/or using this product you acknowledge that you accept these terms and have followed the fitting instructions.